

Bandpass Filter 222151B



1. Features

- IF bandpass filter
- Low-Loss Filter
- Single-ended operation
- Ceramic Surface Mount Device(SMD) Package
- Maximum Storage Temperature Range : -40℃ ~ 85℃
- Electrostatics Sensitive Device (ESD)

2. Package Dimension

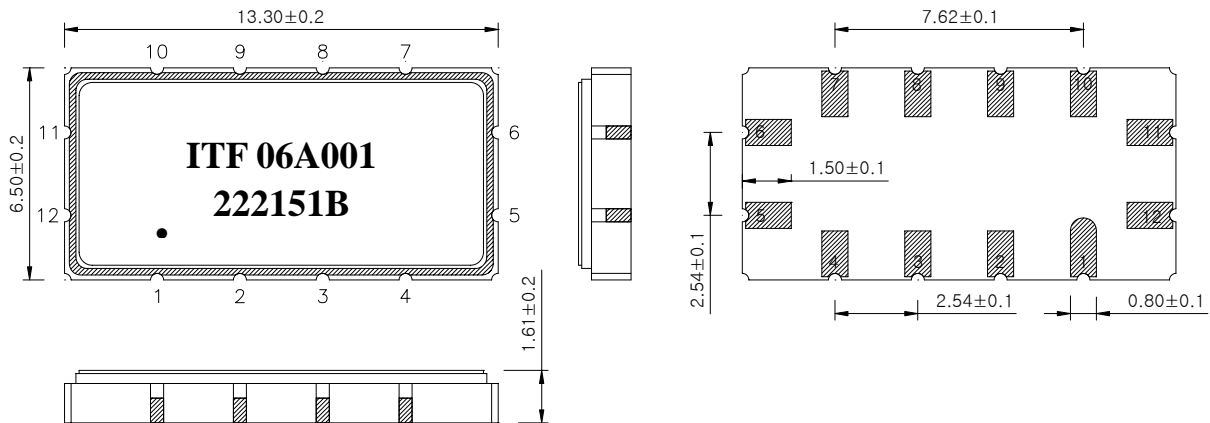

Package : S1365

Dimensions shown are nominal in millimeters

Body : Al₂O₃

Lid : Kovar, Ni Plated

Termination : Au plating 0.3 ~ 1.0um, over a 1.27 ~ 8.89um Ni Plating

Pin Configuration	
11	Input
5	Output
6, 12	Ground
Other	Case ground

	ITF Co., Ltd. 102-901, Bucheon Technopark 364, Samjeong-Dong, Ojeong-Gu, Bucheon-City, Gyeonggi-Do, Korea 421-809	Part No.	222151B	
		Rev. Date	2006-08-29	
		Rev.	NJ6019-CS02	1/5

Bandpass Filter 222151B



3. Specifications

Fo = 60.0 MHz

Terminating source impedance : 50Ω and matching network

Terminating load impedance : 50Ω and matching network

Operating temperature range : -10℃ ~ +70℃		Minimum	Typical	Maximum
Center Frequency	MHz	-	60.0	-
Insertion Loss	dB	-	14.5	17.0
1dB Bandwidth	MHz	20.0	20.7	-
3dB Bandwidth	MHz	-	21.5	-
40dB Bandwidth	MHz	-	24.8	25.0
Amplitude Ripple (Fo +/- 9.75 MHz)	dB	-	0.6	1.0
Group Delay Variation (Fo +/- 9.75 MHz)	nsec	-	40	80
Absolute Delay	usec	-	1.29	-
Ultimate Rejection	dB	40	45	-
Temperature Coefficient of Frequency	ppm/°C	-	-86	-

Room temperature : + 25℃		Minimum	Typical	Maximum
Center Frequency	MHz	-	60.0	-
Insertion Loss	dB	-	14.5	16.5
Amplitude Ripple (Fo +/- 10.0 MHz)	dB	-	0.6	1.0
Group Delay Variation (Fo +/- 10.0 MHz)	nsec	-	40	80

 Integrated Technology Future	ITF Co., Ltd. 102-901, Bucheon Technopark 364, Samjeong-Dong, Ojeong-Gu, Bucheon-City, Gyeonggi-Do, Korea 421-809	Part No.	222151B	
		Rev. Date	2006-08-29	
		Rev.	NJ6019-CS02	2/5

Bandpass Filter 222151B



Notes :

- 1) All specifications are based on the matching schematic shown below
- 2) All specifications are measured by Agilent Network analyzer and full 2 port calibration
- 3) Electrical margin has been built into the design to account for the variations due to temperature drift and manufacturing tolerances
- 4) All attenuation measurements are measured relative to insertion loss

4. Matching Schematic

(Actual matching values may vary due to PCB layout and parasitics)

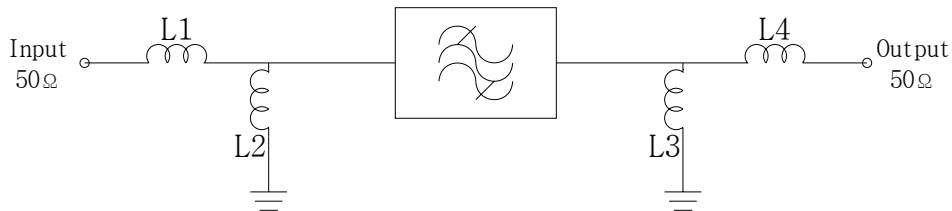

L1 = 120 nH, L2 = 220nH
L3 = 220nH, L4 = 68nH

5. Marking Configuration

ITF¹⁾ 06A001²⁾

222151B³⁾

● 4)

- 1) Manufacturer name
- 2) Lot Number
- 3) Part Number
- 4) Pad Number 1 Index

	ITF Co., Ltd. 102-901, Bucheon Technopark 364, Samjeong-Dong, Ojeong-Gu, Bucheon-City, Gyeonggi-Do, Korea 421-809	Part No.	222151B	
		Rev. Date	2006-08-29	
		Rev.	NJ6019-CS02	3/5

Bandpass Filter 222151B



6. Typical Performance (at +25°C)

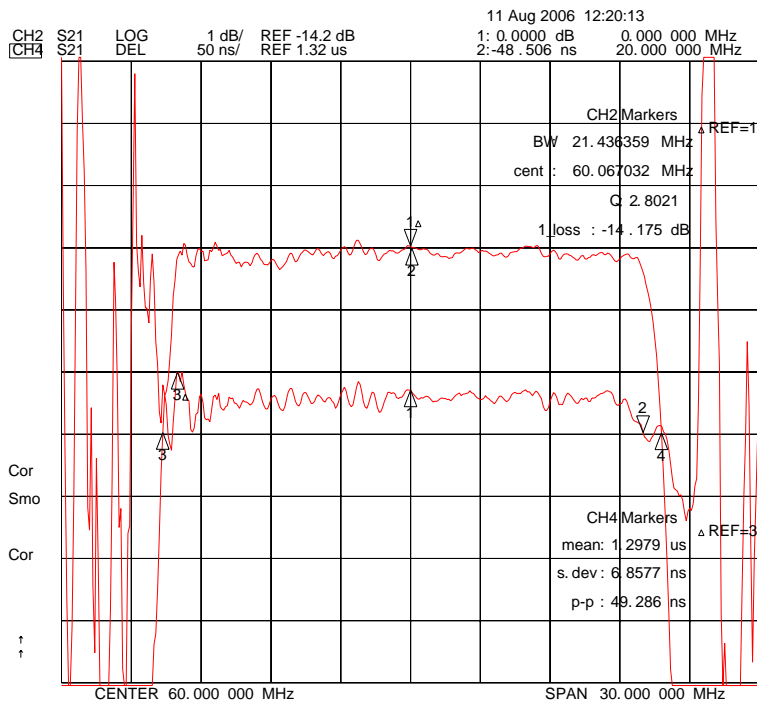
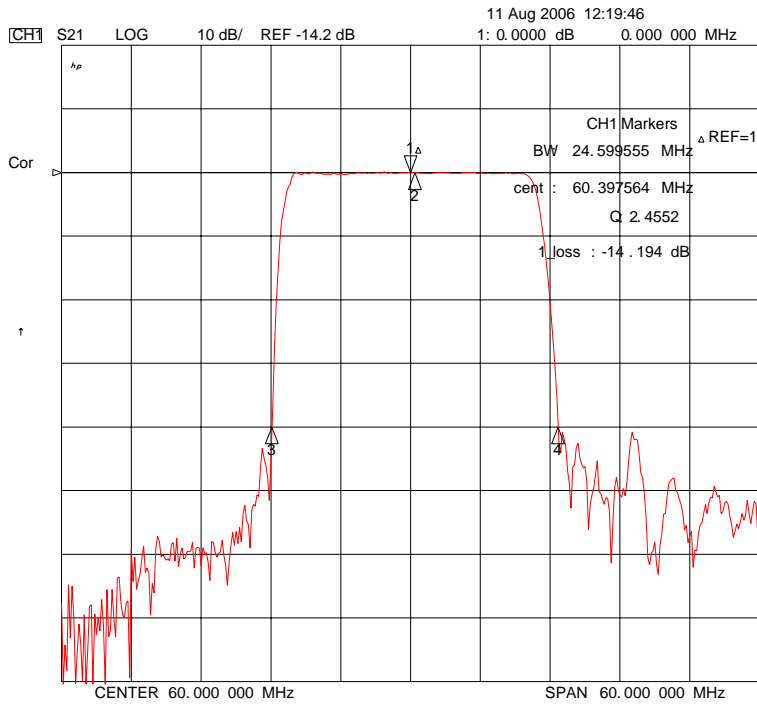

ITF Co., Ltd.
 102-901, Bucheon Technopark 364,
 Samjeong-Dong, Ojeong-Gu, Bucheon-City,
 Gyeonggi-Do, Korea 421-809

Part No.

222151B

Rev. Date

2006-08-29

Rev.

NJ6019-CS02

4/5

Bandpass Filter 222151B

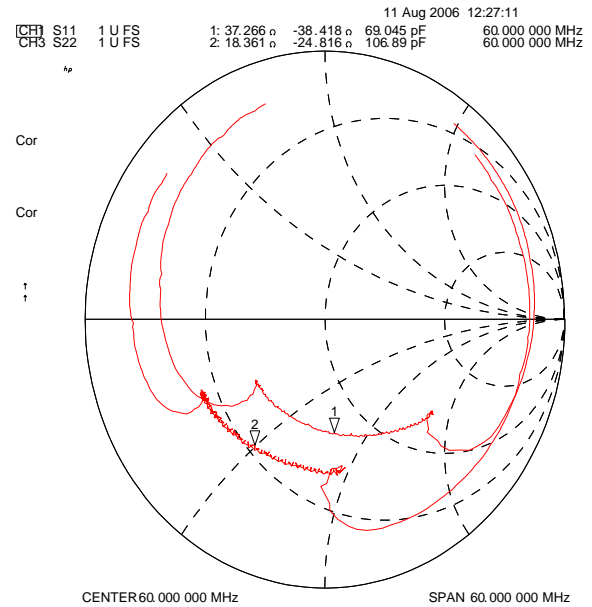
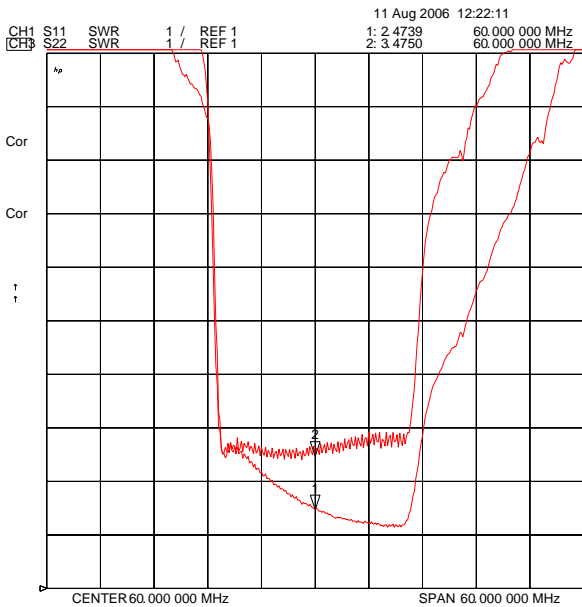
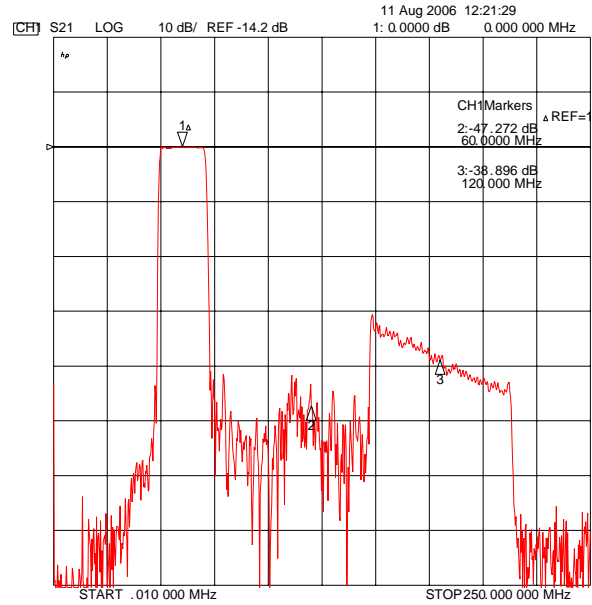
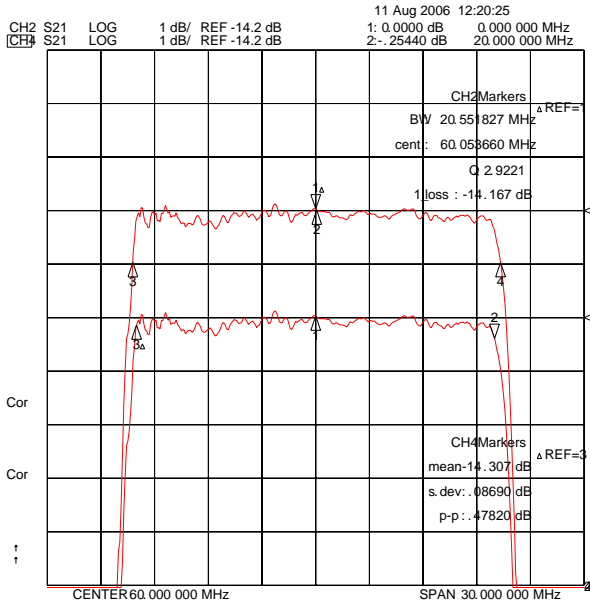

ITF Co., Ltd.
 102-901, Bucheon Technopark 364,
 Samjeong-Dong, Ojeong-Gu, Bucheon-City,
 Gyeonggi-Do, Korea 421-809

Part No. 222151B

Rev. Date 2006-08-29

Rev. NJ6019-CS02 5/5